

## PME1265

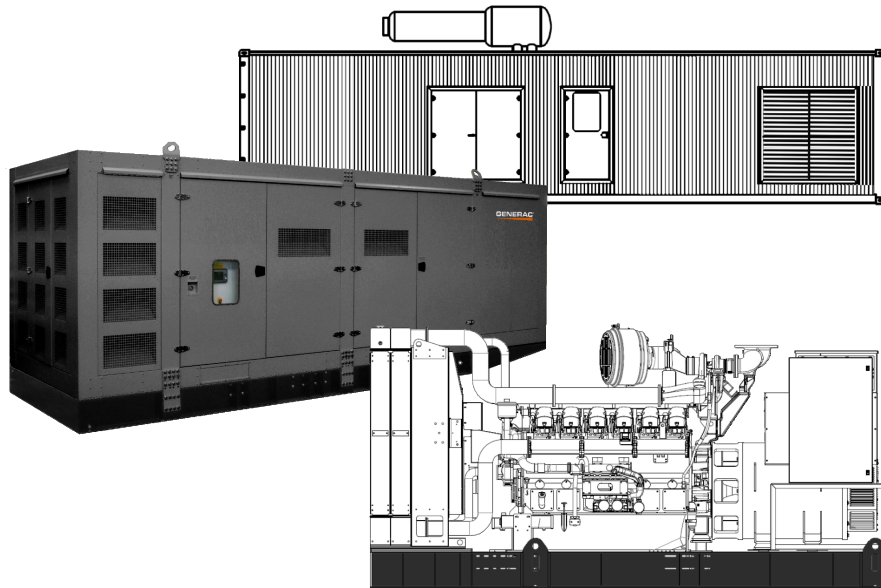

### Power Rating

Emergency Standby Power ESP	kVA	1266
Emergency Standby Power ESP	kW	1013
Prime Power PRP	kVA	1136
Prime Power PRP	kW	909
Voltage	V	400/230
Frequency	Hz	50
Power factor	cos $\phi$	0.8
Phase		3
Fuel		Diesel

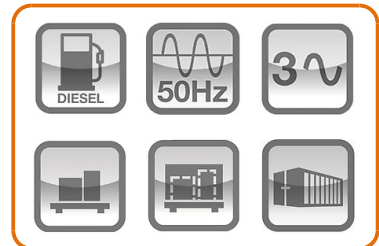

### Ratings definition (ISO-8528)

#### ESP - Emergency Standby Power:

It is the maximum power available during a variable electrical power sequence, under the stated operating conditions, for which a generating set is capable of delivering in the event of a utility power outage or under test conditions for up to 200 h of operation per year with the maintenance intervals and procedures being carried out as prescribed by the manufacturers. The permissible average power output over 24 h of operation shall not exceed 70 % of the ESP.

#### PRP - Prime Power:

It is defined as being the maximum power which a generating set is capable of delivering continuously whilst supplying a variable electrical load when operated for an unlimited number of hours per year under the agreed operating conditions with the maintenance intervals and procedures being carried out as prescribed by the manufacturer. The permissible average power output over 24 h of operation shall not exceed 70 % of the prime power.

**G2 class load acceptance in accordance with ISO 8528-5:2013** Higher performance classes check upon request.

#### Generators are compliant with EC mark which includes the following directives:

- 2006/42/CE Machinery safety.
- 2014/30/UE Electromagnetic compatibility.
- 2014/35/UE electrical equipment designed for use within certain voltage limits
- 2000/14/EC Sound Power level. Noise emissions outdoor equipment. (amended by 2005/88/EC) - If applicable
- 97/68/EC Emissions of gaseous and particulate pollutants. (amended by 2002/88/EC & 2004/26/EC) - If applicable
- EN 12100, EN 13857, EN 60204

**Company with quality certification ISO 9001**



## Engine specifications

Engine Brand	Perkins	
Model	4008 30TAG3	
Operating Speed-Nominal	rpm	1500
Engine cooling system	Water	
[50Hz] Exhaust emission level	Unregulated	
Nr. of cylinder and disposition	8 in line	
Displacement	cm <sup>3</sup>	30561
Aspiration	Turbocharged aftercooled	
Speed governor	Electronic	
Maximum gross power LTP ESP	kW	1105
Prime gross power PRP	kW	997
Fan consumption	kW	50
Cooling fan air flow rate	m <sup>3</sup> /min	1104
Oil capacity	l	153
Lube oil consumption PRP (max)	%	0.2
Coolant capacity	l	140
Fuel	Diesel	
Specific fuel consumption 75% PRP	g/kWh	202
Starting system	Electric	
Starting engine capability	kW	8.2
Electric circuit	V	24

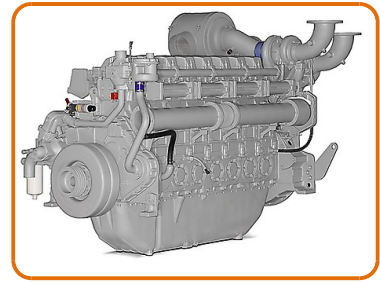

## Alternator Specifications

Alternator	Mecc Alte	
Model	ECO43-2LN/4	
Windings connection	Parallel Star	
Frequency	Hz	50
Voltage	V	400
Phases	3	
Power factor	cos $\phi$	0.8
Emergency peak power 163°/27°	kVA	1420
Efficiency @ 75% load	%	96.2
Type	Brushless	
Poles	4	
Voltage regulation system	Electronic	
Standard AVR	DER1	
Voltage tolerance	%	0.5
Class	H	
IP protection	23	
Cooling air	m <sup>3</sup> /s	1.5



## Genset Equipment - Basic Configurations Available

Battery	n	2
Battery Capacity	Ah	200
INTEGRATED FUEL TANK - VERSIONS AVAILABLE		:
IFT1 - Integrated Fuel Tank (steel)	l	500
IFT2 - Integrated Fuel Tank (steel)	l	1000



### Supplements available:

MBS - Manual Battery Switch	●
FBD - Fully bunded base frame	●
LDS - Leakage detection sensor (only with FBD)	●
FCV - Fuel Cut Off Valve	●
AFP - Automatic Fuel Pump	●
DFP - Double Automatic Fuel Pump	●
PHS - Coolant Pre-Heating System	●
ALS - Automatic Lube Oil Top Up System with lube oil tank	●
Other Configurations and-or special versions available on requests	.

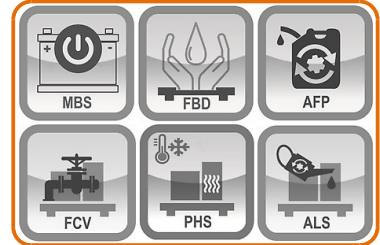

### Installation data

Total air flow	m <sup>3</sup> /min	1278
Exhaust gas flow	m <sup>3</sup> /min	203
Exhaust gas temperature	°C	482
Fuel consumption 100% PRP	l/h	244.50
Fuel consumption 75% PRP	l/h	182.47
IFT1 - Running time 75% PRP	h	2.74
IFT2 - Running time 75% PRP	h	5.48



### Electrical Data

Battery Voltage	V	24
Genset Voltage	V	400/230
Frequency	Hz	50
Phases		3
Power Factor	cos φ	0.8
Nominal current	A	1640
Max current	A	1827
Circuit breaker	A	2000



### Control panel - Options Available:

AUTOMATIC CONTROL PANEL	ACP
MODULAR PARALLEL PANEL	MPP



### ACP - AUTOMATIC CONTROL PANEL

- Auto Mains Failure (AMF) function
- Gen-set controller for single genset operating in standby or prime power modes
- Full gen-set monitoring and protection
- Detailed event and performance log with time and date
- Wide range of remote control modules available as option
- Wide range of I/O expansion modules available as option



Power supply by terminal bus bar

### ACP - Power Panel - Breakers Available:

GCB1 - Genset Circuit Breaker 3-pole	A	2000
GCB2 - Genset Circuit Breaker 4-pole	A	2000
ETB - External Terminal Board (with GCB)		Standard

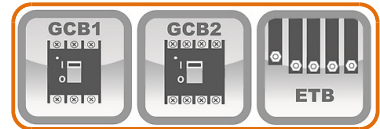

### LTS - Load Transfer Switch [Accessories for ACP Automatic Control Panel]

The Load Transfer Switch (LTS) panel operates the power supply changeover between the generator and the Mains in stand-by applications, guaranteeing load supply in a short period of time. LTS fit inside a sturdy standalone cabinet which can be installed separate from the generating set. The logic control of LTS is operated by the Automatic Control Panel (ACP) of the generating set.

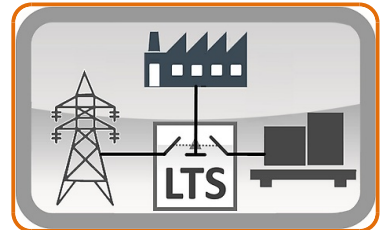

### MPP - MODULAR PARALLEL PANEL

- Modular parallel panel allows the genset to work in parallel (up to 32 gensets)
- 7" full colour display
- Easy switching between parallel to mains or multiple genset applications
- Full gen-set monitoring and protection
- Detailed event and performance log with time and date
- Wide range of communication and connection capabilities available



Power supply by terminal bus bar

### MPP - Power Panel - Breakers Available:

GMB1 - Genset Circuit Breaker 3-pole motorized	A	2000
GMB2 - Genset Circuit Breaker 4-pole motorized	A	2000
ETB - External Terminal Board (with GMB)		Standard

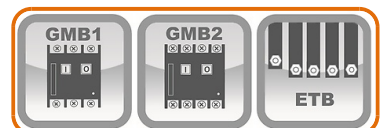

## OPEN VERSION

Baseframe made of welded steel profile  
 Anti-vibration mountings properly sized  
 Lifting points on the baseframe for handling by crane  
 Moving and rotating parts protection against accidental contact  
 Grounding point to connect all metal parts to ground



### Dimensional data Open Version

Length	(L) mm	4620
Width	(W) mm	2200
Height	(H) mm	2310

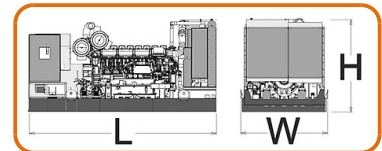

Weight	Kg	11390
--------	----	-------

### OPTIONS AVAILABLE (ONLY FOR OPEN VERSION)

Industrial Exhaust System	IES
Residential Exhaust System	RES



## CANOPY VERSION

Weatherproof Enclosure made of galvanized sheet metal allows to protect genset from corrosion and aggressive condition  
 Soundproofed enclosure tanks to high quality soundproof material and residential silencer, allows to have low noise emission level  
 Big large lateral doors allows an easy service and maintenance operation  
 Doors equipped with key lockable handles  
 Baseframe made of welded steel profile  
 Anti-vibration mountings properly sized  
 Moving and rotating parts protection against accidental contact  
 Grounding point to connect all metal parts to ground  
 Lifting points on the enclosure for handling by crane



### Dimensional data Canopy Version

Length	(L) mm	7800
Width	(W) mm	2424
Height	(H) mm	3000

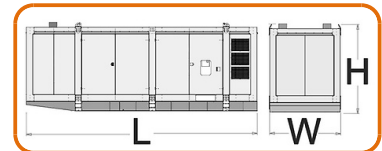

Weight	Kg	11503
--------	----	-------

### Noise Level Canopy Version

Noise pressure level @ 7 m	dB(A)	76
----------------------------	-------	----

## CONTAINER VERSION

Soundproofed Container adaptable to meet all your requirements and needs, equipped with residential silencer positioned inside or on the roof. Sturdy structure similar to shipping containers: upper and lower corner castings, monolithic structure, walls and roof made of corrugated steel sheet.

Reinforced floor structure covered with teardrop patterned steel sheet High resistance to the atmospheric agents.

Air inlet and exhaust openings air outlet for genset cooling.

Large lateral doors allows an easy service and maintenance operation. Doors fixed by sturdy steel hinges equipped with lever bolt locks and panic bars.



### Dimensional data Container Version

Length	(L) mm	12190
Width	(W) mm	2438
Height	(H) mm	3096

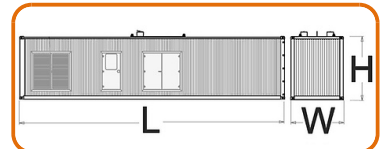

Weight	Kg	15223
--------	----	-------

### Noise Level Container Version

Noise pressure level @ 7 m	dB(A)	77+/-3
----------------------------	-------	--------

The information is aligned with the Data file at the time of download.  
Printed on 10/05/2024 (ID 17890)

©2023 | [www.generacinternational.com](http://www.generacinternational.com)

**GENERAC**